

Please write clearly in block capitals.

Centre number

Candidate number

Surname _____

Forename(s) _____

Candidate signature _____

I declare this is my own work.

GCSE PHYSICS

H

Higher Tier Paper 1

Time allowed: 1 hour 45 minutes

Materials

For this paper you must have:

- a ruler
- a scientific calculator
- the Physics Equations Sheet (enclosed).

Instructions

- Use black ink or black ball-point pen. Pencil should only be used for drawing.
- Fill in the boxes at the top of this page.
- Answer **all** questions in the spaces provided.
- Do not write outside the box around each page or on blank pages.
- If you need extra space for your answer(s), use the lined pages at the end of this book. Write the question number against your answer(s).
- Do all rough work in this book. Cross through any work you do not want to be marked.
- In all calculations, show clearly how you work out your answer.

Information

- The maximum mark for this paper is 100.
- The marks for questions are shown in brackets.
- You are expected to use a calculator where appropriate.
- You are reminded of the need for good English and clear presentation in your answers.

For Examiner's Use	
Question	Mark
1	
2	
3	
4	
5	
6	
7	
8	
9	
10	
11	
TOTAL	



There are no questions printed on this page

*Do not write
outside the
box*

**DO NOT WRITE ON THIS PAGE
ANSWER IN THE SPACES PROVIDED**



Answer **all** questions in the spaces provided.

*Do not write
outside the
box*

0 1

Figure 1 shows an electric car being recharged.

Figure 1

Power cable



Charging station

0 1 . 1

The charging station applies a direct potential difference across the battery of the car.

What does 'direct potential difference' mean?

[1 mark]

Question 1 continues on the next page

Turn over ►



0 1 . 2 Which equation links energy transferred (E), power (P) and time (t)?

[1 mark]

Tick (✓) **one** box.

energy transferred = $\frac{\text{power}}{\text{time}}$

energy transferred = $\frac{\text{time}}{\text{power}}$

energy transferred = power \times time

energy transferred = power² \times time

0 1 . 3 The battery in the electric car can store 162 000 000 J of energy.

The charging station has a power output of 7200 W.

Calculate the time taken to fully recharge the battery from zero.

[3 marks]

Time taken = _____ s



0 1 . 4 Which equation links current (I), potential difference (V) and resistance (R)?

[1 mark]

Tick (✓) **one** box.

$$I = V \times R$$

$$I = V^2 \times R$$

$$R = I \times V$$

$$V = I \times R$$

0 1 . 5 The potential difference across the battery is 480 V.

There is a current of 15 A in the circuit connecting the battery to the motor of the electric car.

Calculate the resistance of the motor.

[3 marks]

Resistance = _____ Ω

Question 1 continues on the next page

Turn over ►



0 1 . 6

Different charging systems use different electrical currents.

- Charging system **A** has a current of 13 A.
- Charging system **B** has a current of 26 A.
- The potential difference of both charging systems is 230 V.

How does the time taken to recharge a battery using charging system **A** compare with the time taken using charging system **B**?

[1 mark]

Tick (✓) **one** box.

Time taken using system **A** is half the time of system **B**

Time taken using system **A** is the same as system **B**

Time taken using system **A** is double the time of system **B**

Do not write
outside the
box

10



Turn over for the next question

*Do not write
outside the
box*

**DO NOT WRITE ON THIS PAGE
ANSWER IN THE SPACES PROVIDED**

Turn over ►



0 2

Energy from the Sun is released by nuclear fusion.

0 2 . 1

Complete the sentences.

[2 marks]

Nuclear fusion is the joining together of _____.

During nuclear fusion the total mass of the particles _____.

0 2 . 2

Nuclear fusion of deuterium is difficult to achieve on Earth because of the high temperature needed.

Electricity is used to increase the temperature of 4.0 g of deuterium by 50 000 000 °C.

specific heat capacity of deuterium = 5200 J/kg °C

Calculate the energy needed to increase the temperature of the deuterium by 50 000 000 °C.

Use the Physics Equation Sheet.

[3 marks]

Energy = _____ J



0 2 . 3

The idea of obtaining power from nuclear fusion was investigated using models.

The models were tested before starting to build the first commercial nuclear fusion power station.

Suggest **two** reasons why models were tested.

[2 marks]

1

2

0 2 . 4

Generating electricity using nuclear fusion will have fewer environmental effects than generating electricity using fossil fuels.

Explain **one** environmental effect of generating electricity using fossil fuels.

[2 marks]

9

Turn over for the next question

Turn over ►



0 3

Student **A** investigated how the current in resistor **R** at constant temperature varied with the potential difference across the resistor.

Student **A** recorded both positive and negative values of current.

Figure 2 shows the circuit Student **A** used.

Figure 2

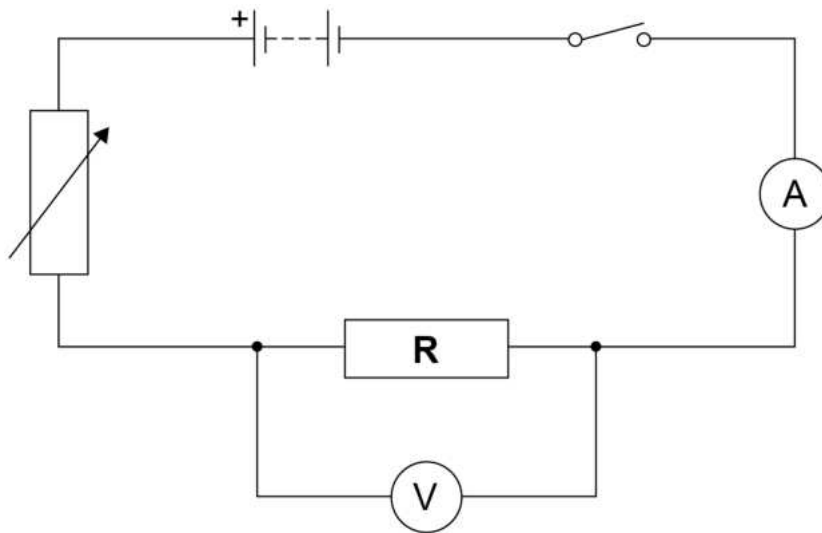

0 3 . 1

Describe a method that Student **A** could use for this investigation.

[6 marks]



0	3	.	2
---	---	---	---

Student **B** repeated the investigation.

During Student **B**'s investigation the temperature of resistor **R** increased.

Explain how the increased temperature of resistor **R** would have affected Student **B**'s results.

[2 marks]

Question 3 continues on the next page

Turn over ►



Figure 3 shows the scale on a moving coil ammeter at one time in the investigation.

Do not write
outside the
box

Figure 3

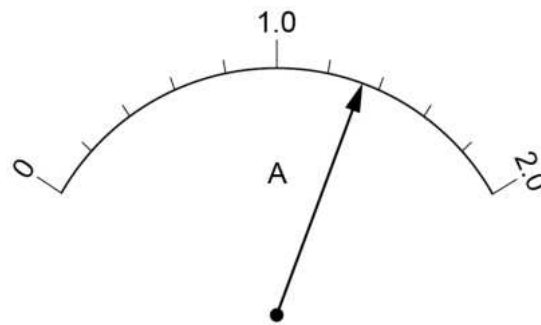

0 3 . 3 What is the resolution of the moving coil ammeter?

[1 mark]

Resolution = _____ A



0 3 . 4 Student **B** replaced the moving coil ammeter with a digital ammeter.

Figure 4 shows the reading on the digital ammeter.

Figure 4

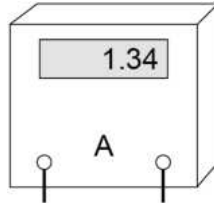

The digital ammeter has a higher resolution than the moving coil ammeter.

Give **one** other reason why it would have been better to use the digital ammeter throughout this investigation.

[1 mark]

10

Turn over for the next question

Turn over ►



0 4

A student investigated the density of different fruits.

Table 1 shows the results.

Table 1

Fruit	Density in g/cm³
Apple	0.68
Kiwi	1.03
Lemon	0.95
Lime	1.05

0 4 . 1

The student determined the volume of each fruit using a displacement can and a measuring cylinder.

What other piece of equipment would the student need to determine the density of each fruit?

[1 mark]



0 4 . 2 Write down the equation which links density (ρ), mass (m) and volume (V).

[1 mark]

0 4 . 3 The mass of the apple was 85 g.

The density of the apple was 0.68 g/cm^3 .

Calculate the volume of the apple.

Give your answer in cm^3 .

[3 marks]

Volume = _____ cm^3

0 4 . 4 The student only measured the volume of each fruit once.

The volume measurements **cannot** be used to show that the method to measure volume gives precise readings.

Give the reason why.

[1 mark]

6

Turn over ►



0 5 . 1

During one year, 1.25×10^{18} J of energy was transferred from the National Grid.

number of seconds in 1 year = 3.16×10^7

Calculate the mean energy transferred from the National Grid each second.

Give your answer to 3 significant figures.

[2 marks]

Energy each second (3 significant figures) = _____ J

Figure 5 shows a house with a solar power system.

The solar cells generate electricity.

When the electricity generated by the solar cells is not needed, the energy is stored in a large battery.

Figure 5

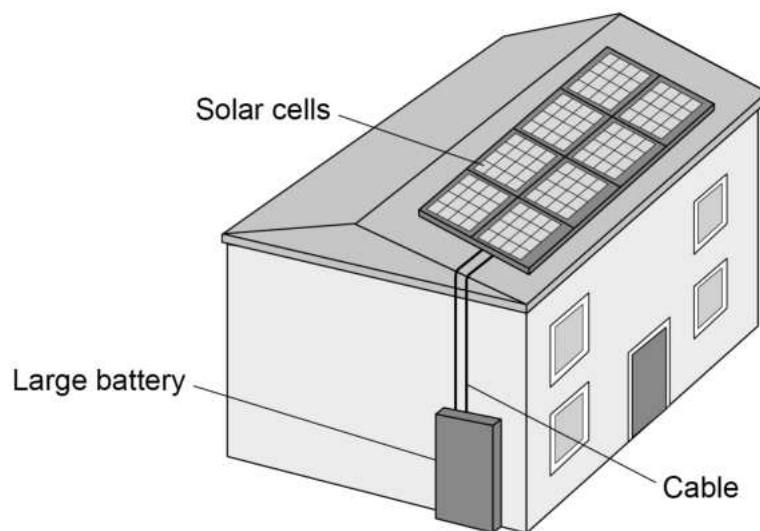

0 5 . 2

The charge flow through the cable between the solar cells and the battery in 24 hours was 27 000 coulombs.

Calculate the mean current in the cable.

[4 marks]

Mean current = _____ A

0 5 . 3

At one time, the total power input to the solar cells was 7.8 kW.

The efficiency of the solar cells was 0.15

Calculate the useful power output of the solar cells.

[3 marks]

Useful power output = _____ W

Question 5 continues on the next page**Turn over ►**

0	5	.	4
---	---	---	---

It is unlikely that **all** of the electricity that the UK needs can be generated by solar power systems.

Explain why.

[2 marks]

*Do not write
outside the
box*

11



Turn over for the next question

*Do not write
outside the
box*

**DO NOT WRITE ON THIS PAGE
ANSWER IN THE SPACES PROVIDED**

Turn over ►



0 6

Figure 6 shows the mass number and the atomic number for the nuclei of five different atoms.

Do not write
outside the
box

Figure 6

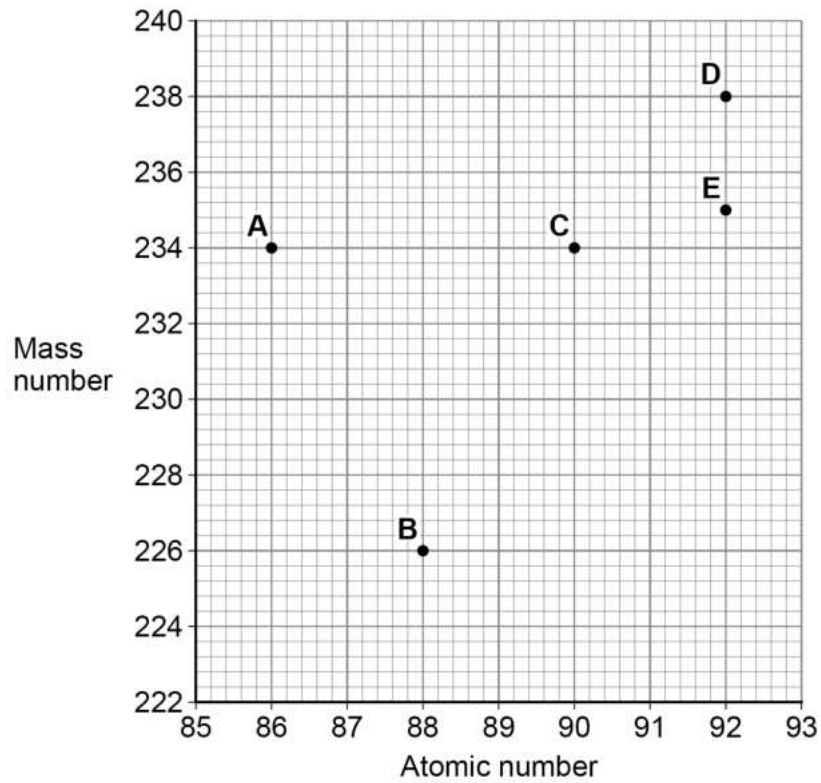

0 6 . 1

How many neutrons are there in a nucleus of atom A?

[1 mark]



0 6 . 2 Which **two** atoms in **Figure 6** are the same element?

[1 mark]

Tick (✓) **one** box.

A and B

A and C

C and D

D and E

Question 6 continues on the next page

Turn over ►



0 6 . 3 Nucleus **B** decays by emitting an alpha particle.

Draw an arrow on **Figure 7** to represent the alpha decay.

[2 marks]

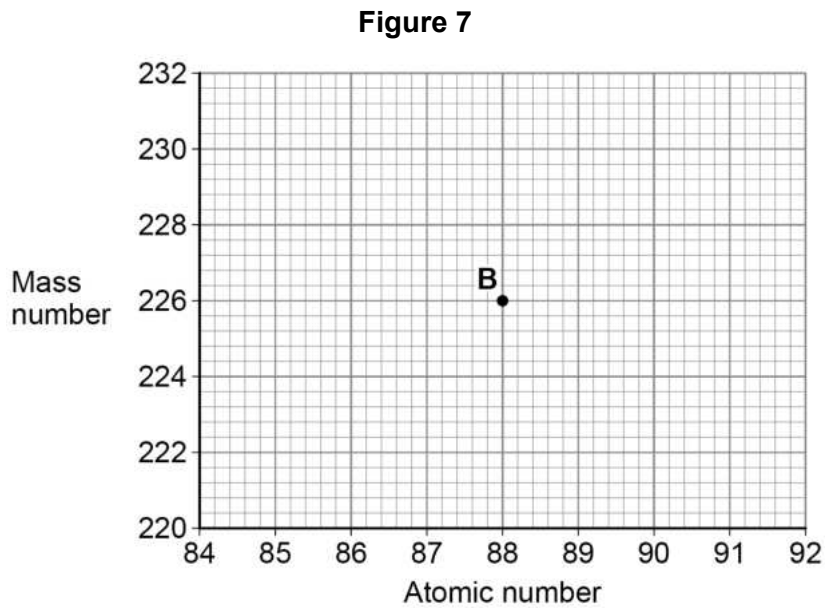

0 6 . 4 What is meant by the 'random nature of radioactive decay'?

[1 mark]



0 6 . 5

A polonium (Po) nucleus decays by emitting an alpha particle and forming a lead (Pb) nucleus.

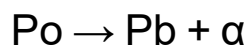

The lead (Pb) nucleus then decays by emitting a beta particle and forms a bismuth (Bi) nucleus.

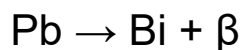

The bismuth (Bi) nucleus then decays by emitting a beta particle and forms a polonium (Po) nucleus.



Explain how these three decays result in a nucleus of the original element, polonium.

[3 marks]

8

Turn over for the next question

Turn over ►



07

A student investigated how the current in a series circuit varied with the resistance of a variable resistor.

Figure 8 shows the circuit used.

Figure 8

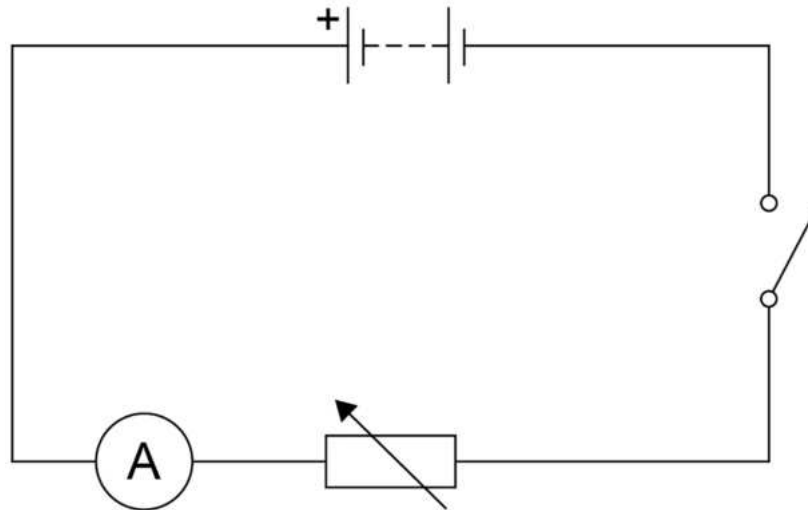
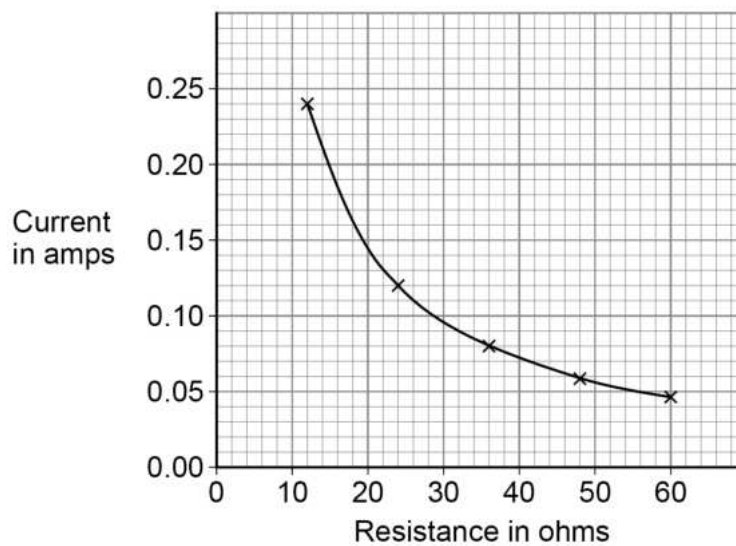

Figure 9 shows the results.

Figure 9



Do not write
outside the
box



0 7 . 1

The battery had a power output of 230 mW when the resistance of the variable resistor was 36Ω .

Determine the potential difference across the battery.

[4 marks]

Potential difference = _____ V

0 7 . 2

The student concluded:

'the current in the circuit was inversely proportional to the resistance of the variable resistor.'

Explain how **Figure 9** shows that the student is correct.

[2 marks]

Question 7 continues on the next page

Turn over ►



07.3

Figure 10 shows a circuit with a switch connected incorrectly.

Do not write
outside the
box

Figure 10

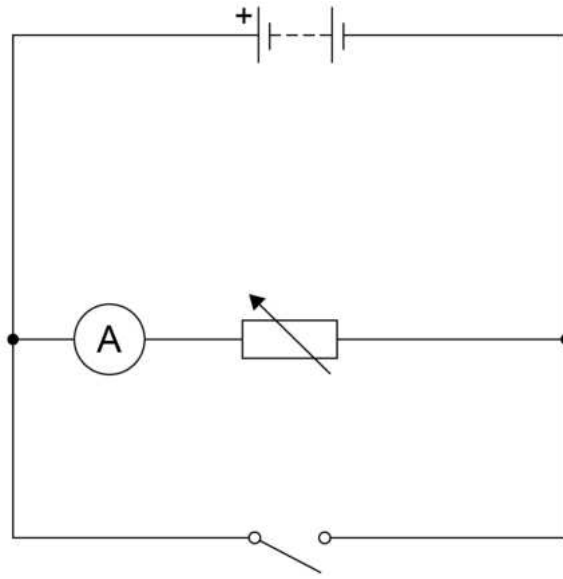

Explain how closing the switch would affect the current in the variable resistor.

[2 marks]

8



Turn over for the next question

*Do not write
outside the
box*

**DO NOT WRITE ON THIS PAGE
ANSWER IN THE SPACES PROVIDED**

Turn over ►



0 8

Figure 11 shows a toy car in different positions on a racing track.

Figure 11

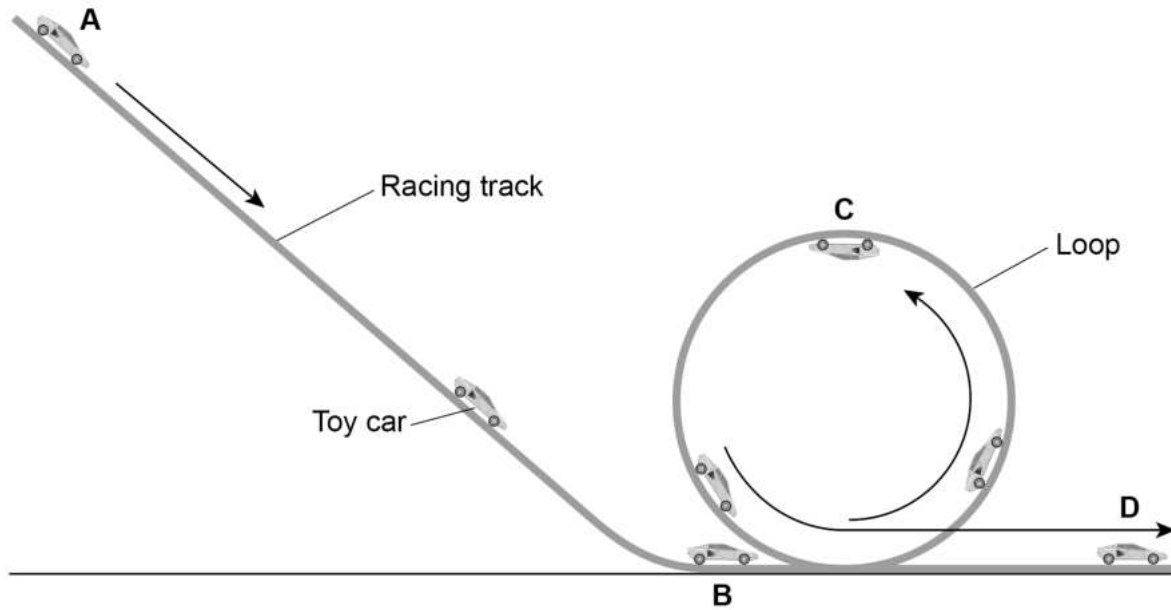

0 8 . 1

The toy car and racing track can be modelled as a closed system.

Why can the toy car and racing track be considered 'a closed system'?

[1 mark]

Tick (✓) **one** box.

The racing track and the car both have gravitational potential energy.

The racing track and the car are always in contact with each other.

The total energy of the racing track and the car is constant.



0 8 . 2

The car is released from rest at position **A** and accelerates due to gravity down the track to position **B**.

mass of toy car = 0.040 kg

vertical height between position **A** and position **B** = 90 cm

gravitational field strength = 9.8 N/kg

Calculate the maximum possible speed of the toy car when it reaches position **B**.

[5 marks]

Speed = _____ m/s

Question 8 continues on the next page

Turn over ►



Figure 11 is repeated below.

Do not write
outside the
box

Figure 11

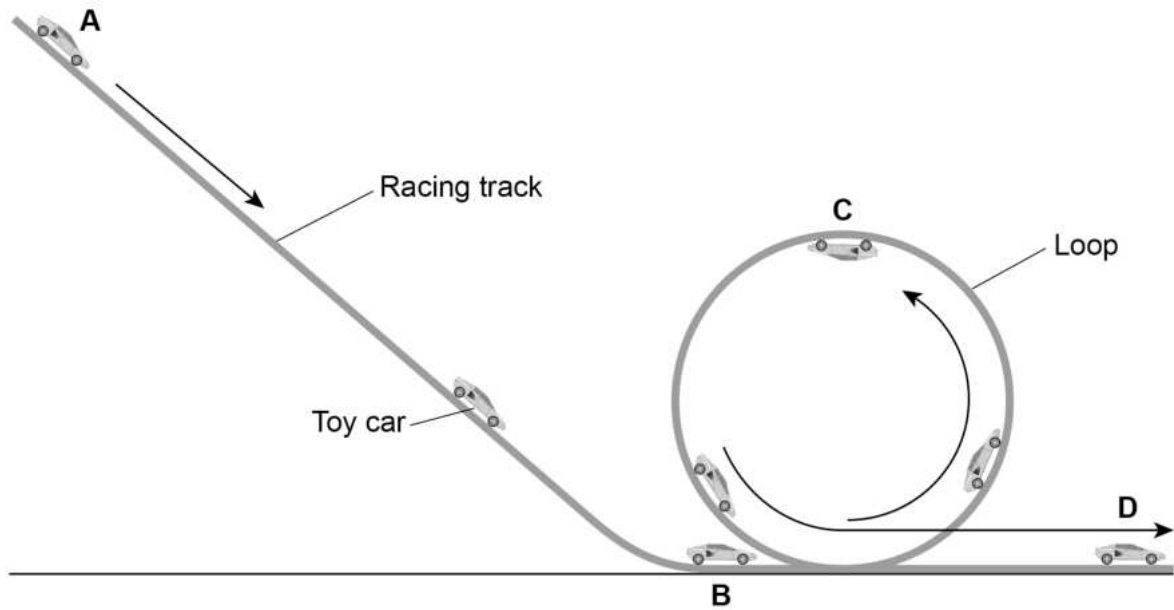

0 8 . 3

At position **C** the car's gravitational potential energy is 0.20 J greater than at position **B**.

How much kinetic energy does the car need at position **B** to complete the loop of the track?

Give a reason for your answer.

[2 marks]

Tick (✓) **one** box.

Less than 0.20 J

Exactly 0.20 J

More than 0.20 J

Reason _____

8



Turn over for the next question

*Do not write
outside the
box*

**DO NOT WRITE ON THIS PAGE
ANSWER IN THE SPACES PROVIDED**

Turn over ►



0 9

A teacher demonstrated the relationship between the pressure in a gas and the volume of the gas.

Figure 12 shows the equipment used.

Figure 12

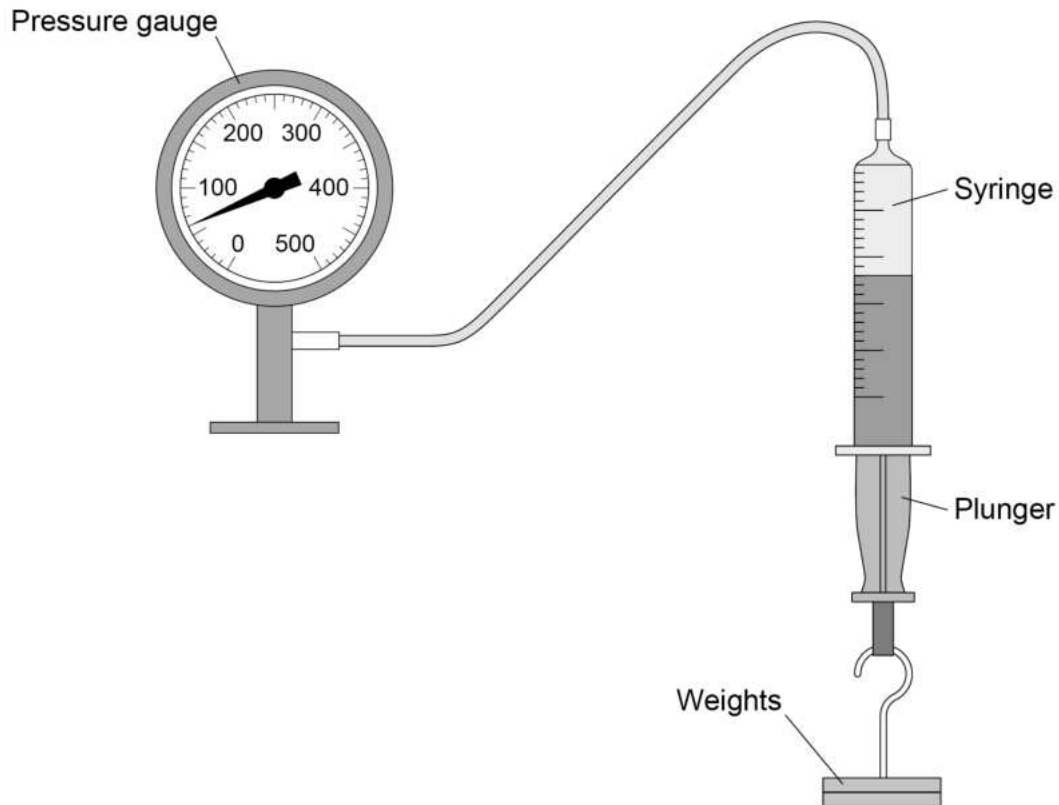

This is the method used.

1. Record the initial volume of gas in the syringe and the pressure reading before any weights are attached.
2. Attach a 2.0 N weight to the syringe.
3. Record the volume of the gas and the reading on the pressure gauge.
4. Repeat steps 2 and 3 until a weight of 12.0 N is attached to the syringe.

0 9 . 1

What was the range of force used?

[1 mark]

From _____ N to _____ N

0 9 . 2

Give **one** control variable in the investigation.

[1 mark]



0 9 . 3

When the volume of gas in the syringe was 45 cm^3 , the pressure gauge showed a value of 60 kPa .

Calculate the pressure in the gas when the volume of gas in the syringe was 40 cm^3 .

[4 marks]

Pressure = _____ kPa

0 9 . 4

When the volume of gas in the syringe increased, the pressure on the inside walls of the syringe decreased.

Explain why.

[3 marks]

9**Turn over for the next question****Turn over ►**

1 0

Figure 13 shows some overhead power cables in the National Grid.

Do not write
outside the
box

Figure 13

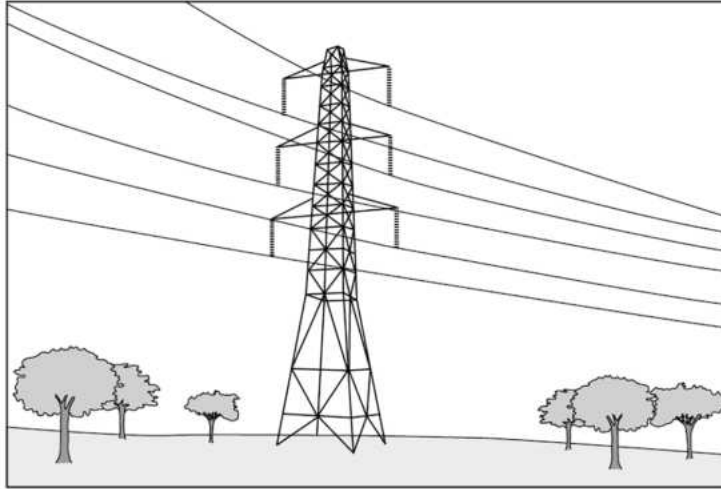

1 0 . 1

Explain the advantage of transmitting electricity at a very high potential difference.

[3 marks]



1 0 . 2

It is dangerous for a person to fly a kite near an overhead power cable.

Figure 14 shows a person flying a kite.

Figure 14



The person could receive a fatal electric shock if the kite was very close to, but not touching the power cable.

Explain why.

[3 marks]

Question 10 continues on the next page

Turn over ►



A scientist investigated how the potential difference needed for air to conduct charge varies with the distance between a cable and earth.

Figure 15 shows the results.

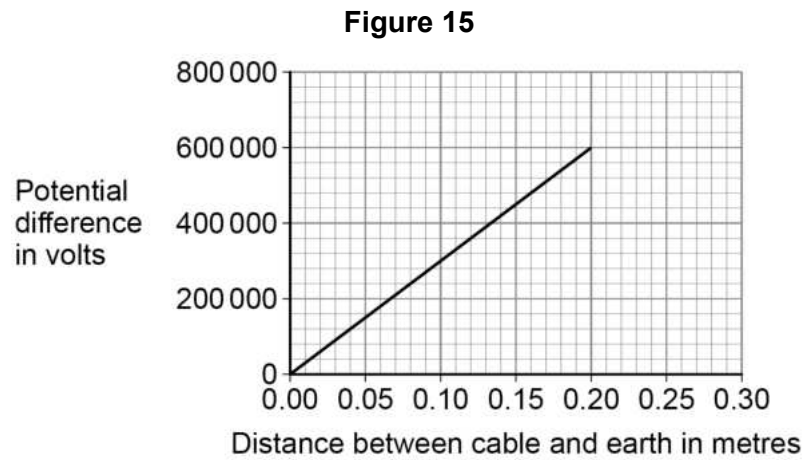

1 0 . 3

The data in **Figure 15** gives the relationship between potential difference and distance when the air is dry.

When the humidity of air increases the air becomes a better conductor of electricity.

Draw a line on **Figure 15** to show how the potential difference changes with distance if the humidity of the air increases.

[2 marks]



1 0 . 4 Figure 16 shows a cross-section through a power cable.

Figure 16

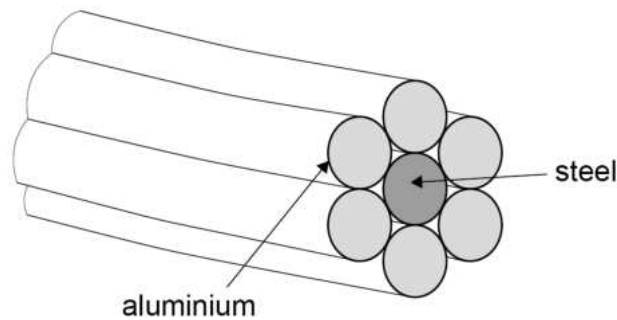

A 1 metre length of a single aluminium wire is a better conductor than a 1 metre length of the steel wire.

The individual wires behave as if they are resistors connected in parallel.

Explain why the current in the steel wire is different to the current in a single aluminium wire.

[2 marks]

10

Turn over for the next question

Turn over ►



1 1

A student investigated how the temperature of a lump of ice varied as the ice was heated.

The student recorded the temperature until the ice melted and then the water produced boiled.

Figure 17 shows the student's results.

The power output of the heater was constant.

Figure 17

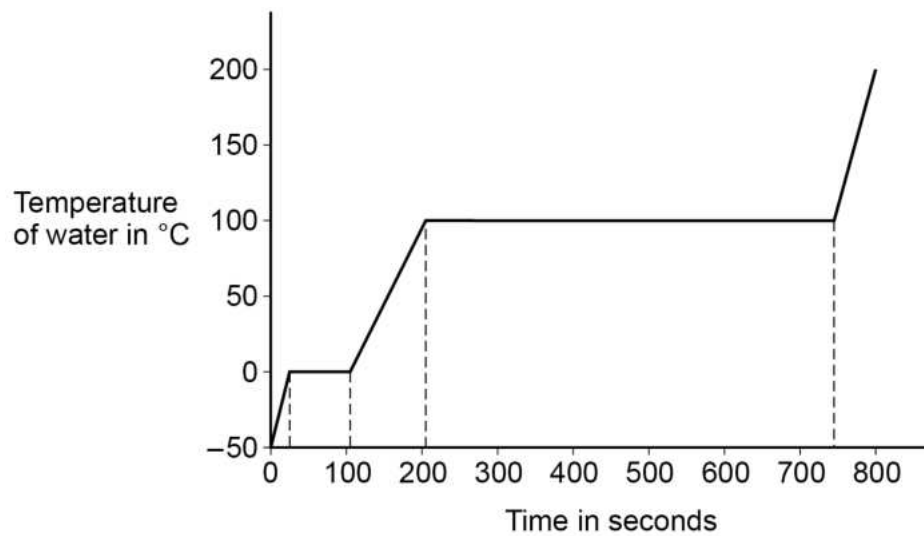

1 1 . 1

The specific heat capacity of ice is less than the specific heat capacity of water.

Explain how **Figure 17** shows this.

[2 marks]



1 1 . 2

The specific latent heat of fusion of ice is less than the specific latent heat of vaporisation of water.

Explain how **Figure 17** shows this.

[2 marks]

1 1 . 3

A second student did the same investigation and recorded the temperature until the water produced boiled.

In the second student's investigation more thermal energy was transferred to the surroundings.

Describe **two** ways the results of the experiment in **Figure 17** would have been different.

[2 marks]

1 _____

2 _____

Question 11 continues on the next page

Turn over ►



1 1 . 4

When the water was boiling, 0.030 kg of water turned into steam.

The energy transferred to the water was 69 kJ.

Calculate the specific latent heat of vaporisation of water.

Give the unit.

[5 marks]

Specific latent heat of vaporisation = _____

Unit _____

11

END OF QUESTIONS



There are no questions printed on this page

*Do not write
outside the
box*

**DO NOT WRITE ON THIS PAGE
ANSWER IN THE SPACES PROVIDED**



*Do not write
outside the
box*

Question number	<p align="center">Additional page, if required. Write the question numbers in the left-hand margin.</p>
	<hr/> <hr/> <hr/> <hr/> <hr/> <hr/> <hr/> <hr/> <hr/> <hr/> <hr/> <hr/> <hr/> <hr/> <hr/> <hr/> <hr/> <hr/> <hr/> <hr/> <hr/> <hr/> <hr/> <hr/> <hr/>
	<p>Copyright information</p> <p>For confidentiality purposes, all acknowledgements of third-party copyright material are published in a separate booklet. This booklet is published after each live examination series and is available for free download from www.aqa.org.uk.</p> <p>Permission to reproduce all copyright material has been applied for. In some cases, efforts to contact copyright-holders may have been unsuccessful and AQA will be happy to rectify any omissions of acknowledgements. If you have any queries please contact the Copyright Team.</p> <p>Copyright © 2021 AQA and its licensors. All rights reserved.</p>

